

VK 125

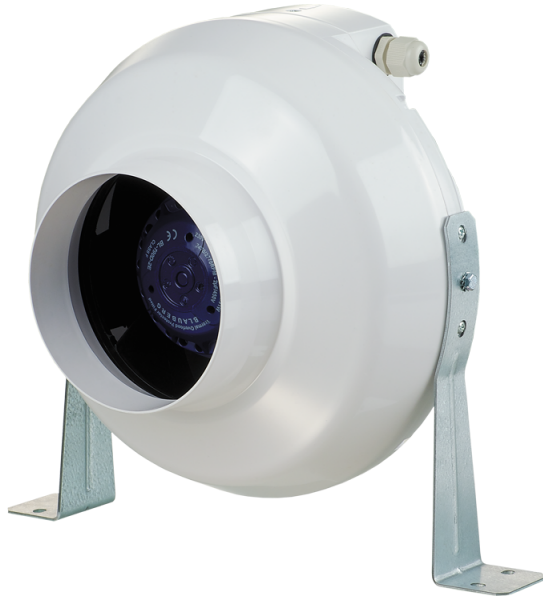

Inline centrifugal fans in plastic casing

- Maximum airflow: 355
- Motor type: AC
- Impeller type: Centrifugal backward curved blades
- Casing material: Plastic
- Installation in any position

	Unit of measurement	VK 125
Connected air duct size	mm	125
Speed	-	1
Minimum supply voltage	V	220
Maximum supply voltage	V	240
Power supply frequency	Hz	50/60
Rated power	W	79
Unit current	A	0.34
Maximum airflow	m ³ /h	355
Weight	kg	2.2
Transported air temperature (max)	°C	55
Transported air temperature (min)	°C	-25
Ingress protection rating	-	IPX4

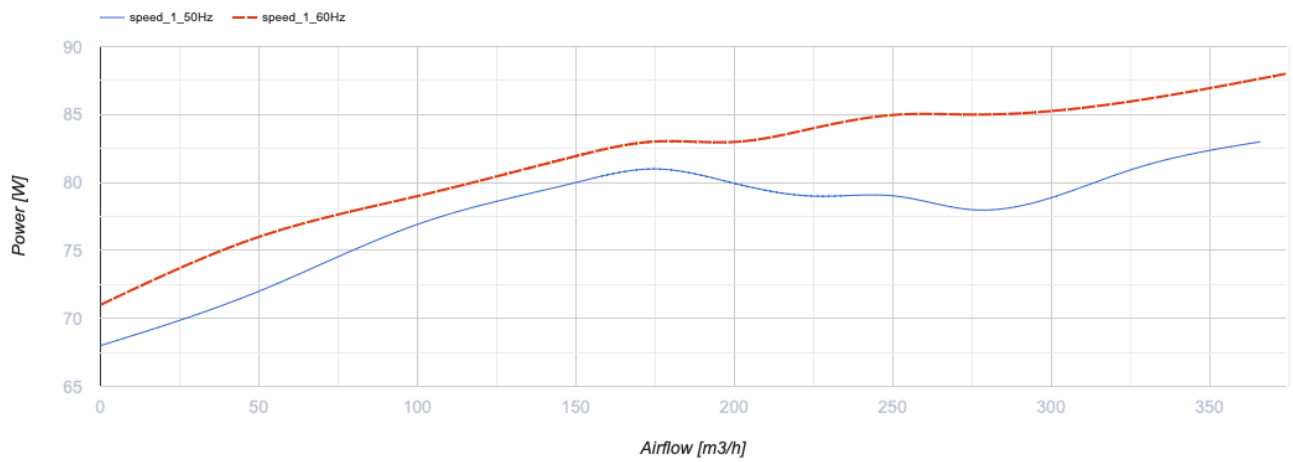
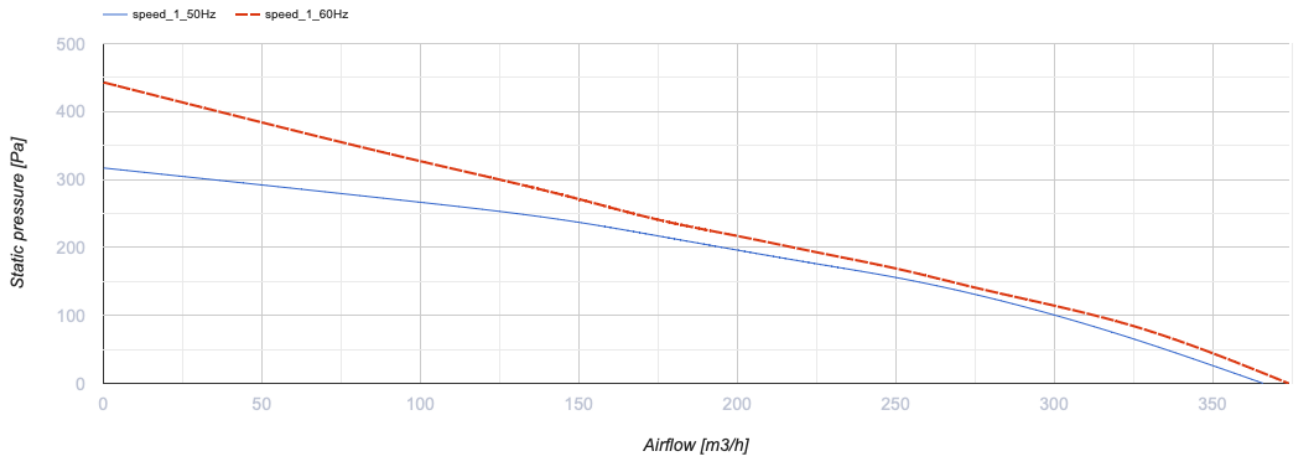

Dimensions

ØD	ØD1	B	L	L1	L2	L3
125	250	270	220	30	27	30

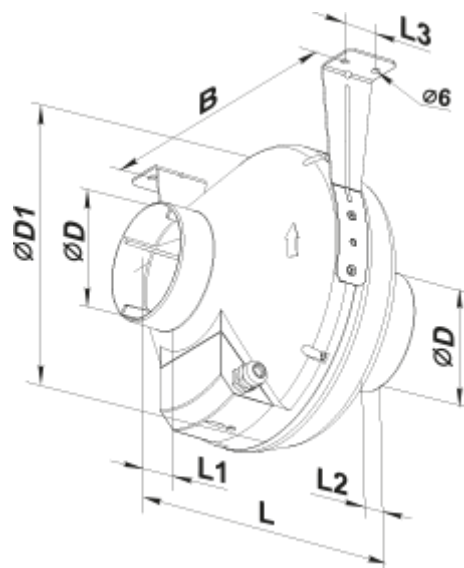

Ecodesign

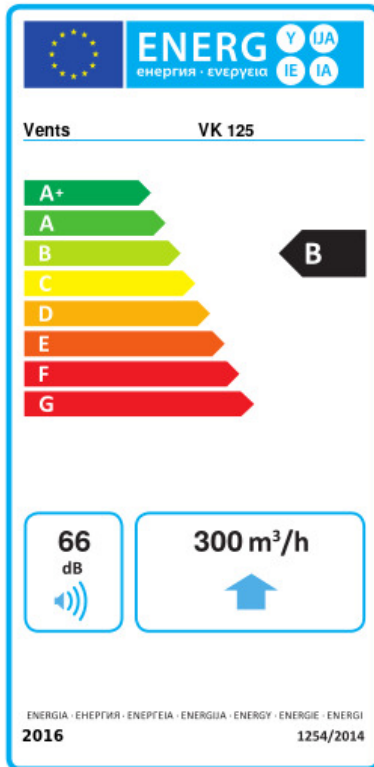

Trademark	Vents					
Model	VK 125					
Specific energy consumption (SEC) (kWh/(m ² /a))	Cold		Average		Warm	
	53.2	A+	26.1	B	10.6	E
Type of ventilation unit	Unidirectional					
Type of drive installed	Variable speed					
Type of heat recovery system	None					
Maximum flow rate (m ³ /h)	300					
Electric power input (W)	79					
Reference flow rate (m ³ /s)	0.058					
Reference pressure difference (Pa)	50					
Specific power input (SPI) (W/(m ³ /h))	0.167					
Control typology	Local demand control					
Maximum external leakage rates (%)	2.7					
Declared typology	RVU UVU					
Sound power level (dB(A))	66					
The annual electricity consumption (AEC) (kWh/a)	Cold		Average		Warm	
	88		88		88	
The annual heating saved (AHS) (kWh/a)	Cold		Average		Warm	
	5536		2830		1280	